

## ASSEMBLY AND INSTALLATION OF NSK LINEAR GUIDES (GENERAL INDUSTRIAL APPLICATIONS)



# Linear Guide: Handling Precautions

NSK linear guides are high quality and are easy to use. NSK places importance on safety in design. For maximum safety, please follow precautions as outlined below.

## (1) Lubrication



- Remove the rust preventative rail-coating before installation. If you are using oil as a lubricant, consult NSK for compatibility issues with the pre-packed factory grease.

## (2) Handling



- Interchangeable ball slides (randomly matching types between rail and ball slide) are installed to the provisional rail when they leave the factory. Handle the ball slide with care during installation to the rail.
- Do not disassemble the guide unless absolutely necessary.
- Ball slide will move easily. Make sure that the ball slide does not disengage from the rail.
- Standard end cap is made of plastic and may break if a direct force is applied.

## (3) Precautions in use



- Make every effort not to allow dust and foreign objects to enter.
- The temperature of the place where linear guides are used should not exceed 80°C (excluding heat-resistant type linear guides.) A higher temperature may damage the plastic end cap.
- If the user cuts the rail, thoroughly remove burrs and sharp edges on the cut surface.
- When hanging upside-down (e.g. the rail is installed upside-down on the ceiling in which the ball slide faces downward), should the end cap be damaged, causing the balls to fall out, the ball slide may be detached from the rail and fall. For such use, take measures including installing a safety device.

## (4) Storage



- Linear rail may bend if stored inappropriately. Place it on a suitable surface, and store it in a flat position.

# Installation Procedures

Thank you for choosing NSK linear guides. This manual briefly describes the recommended handling and installation of NSK linear guides for general industrial use.

There are two methods of installing linear guides. The first uses a datum shoulder on the mounting base and provides accurate horizontal alignment in the same way used for machine tools. The other method uses the first rail as a reference for the second rail and is generally used when smooth motion versus high accuracy is required.

NSK recommends the interchangeable series NH and NS linear guides for general industrial applications. Their self-aligning feature means a greater tolerance for alignment errors and less time spent on installation. Also, they are interchangeable between rail and slider, easily allowing the addition or replacement of parts.

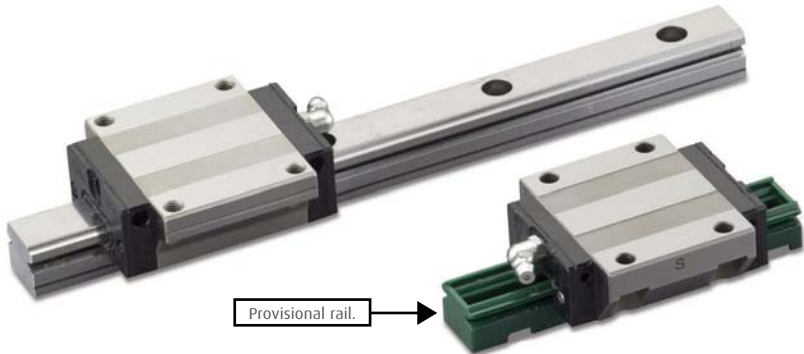

For interchangeable NH and NS Series linear guides, the ball slides and the rails are stocked separately. The ball slides are mounted on plastic provisional rails that allows for easy transfer of the ball slide to and from the steel rail.

The ball slides are designed with retaining wires to prevent the balls from falling out when they are removed from the rail. However, NSK recommends that the ball slides should be stored on a provisional rail prior to installation to prevent contamination from dust and other foreign objects.



The following is a description of how the ball slide should be removed from and replaced on the linear guide rail.

The ball slide is held on the provisional rail using a rubber band. The rubber band should catch the bottom channel in the provisional rail and then twist around to secure the ball slide.

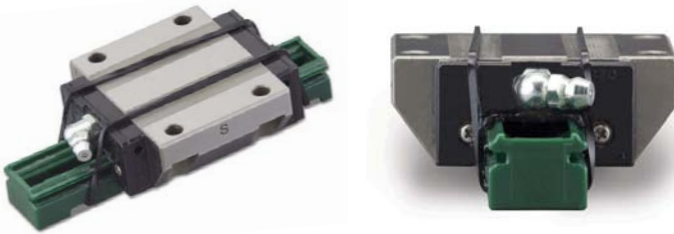

When transferring the ball slide from the provisional rail onto the rail, or vice versa, butt the provisional rail up against the rail and slide the ball slide directly from one onto the other. It is a good idea to secure the ball slide onto the provisional rail with a rubber band after removal from the rail.

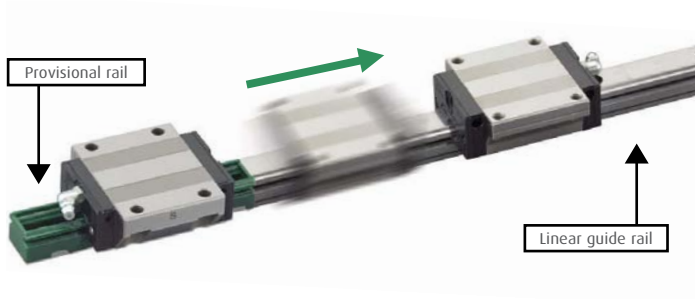

If a ball is accidentally dropped from the ball slide, it should be cleaned and replaced to the appropriate groove. The correct groove can be determined by the size of the clearance between the balls (the groove missing the ball will have greater clearance than the other grooves). It is normal to have a gap of 1.5 ball diameters in each groove.



The following section describes how to install the linear guides on the machine.

Ball slides and rails are supplied separately. Each is wrapped in vinyl sheet, and packed in a container.

Plastic and brass rail caps are an available option for use in high contamination areas to prevent debris build-up in the bolt holes which may damage the slider. Please request these at time of order.

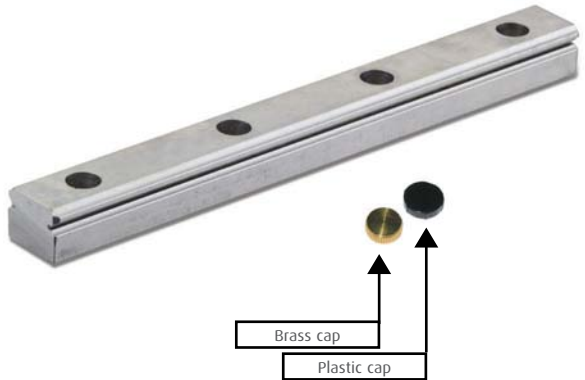

The rail is always shipped with rust preventive oil, which should be wiped off before use. NH and NS Series ball slides are pre-packed with grease, so no cleaning is required prior to installation.

Now the linear guide is ready for installation. Place it carefully on the mounting surface.

### For Smooth Motion of General Machinery

Snugly tighten the mounting bolts temporarily so that the rail is firmly against the bed.

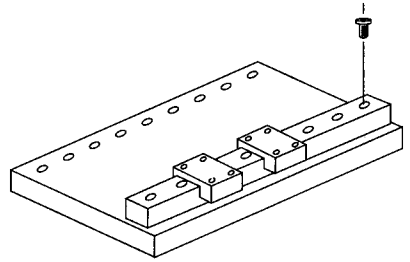

Then tighten the bolts with a torque wrench to the specified torque starting from one end.

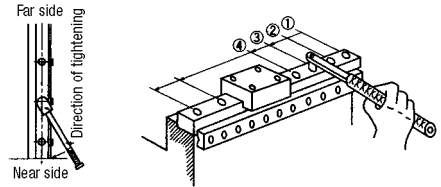

In NSK linear guides, the mounting bolt holes are processed after heat treatment using a precision machining center; therefore, the bolt hole pitch accuracy is as good as the positioning accuracy of the machine, which is considered very good.

When tightening the bolts, be sure to start at one end and work in order to the other end. If the bolts are tightened at the middle first, it tends to leave the rail curved. If you suspect this has happened, loosen the bolts and start again.

The rail that has been tightened can now be used as a reference rail. Using a vernier calipers or other accurate tool, measure the distance between the two rails, and adjust each end until they are the same. Tighten a bolt snug at each end of the rail.

The next step is to install the table, and to use the table to align the rails.

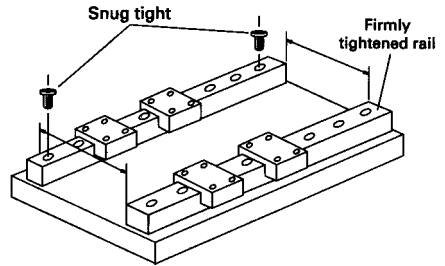

Firmly bolt the table to ball slides 1 and 2 on the firmly secured rail as shown in the diagram. Then position ball slide 3 at the left end of the adjusting rail, and bolt the table to this ball slide. Move the ball slide 3 to right and bolt the table to the ball slide 4.

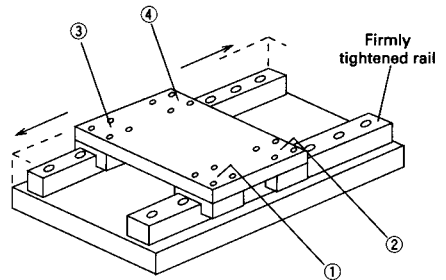

Move the table to one end of the rails, and start tightening the adjusting rail bolt sequentially to the specified torque while checking excessive friction of table movement. Continue moving the table down the rail tightening each adjacent bolt until they have all been tightened.

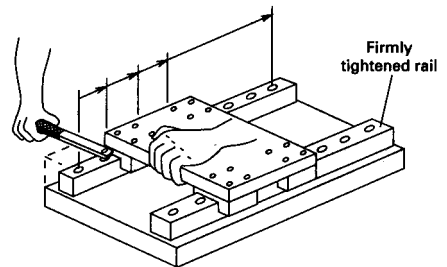

This method of assembly is for general industrial machinery where smooth linear motion is the overall objective. When precision accuracy is required, read on to the following procedure.

## For Greater Accuracy of General Machinery

When bolting the first rail on the machine base, align it straight using a straightedge and a dial indicator.

Bolt on the rail at the both ends lightly, and position a straightedge beside it. Set the straightedge parallel to the rail measuring distance  $A_1$  and  $A_2$  by a vernier calipers or some other accurate measuring tool.

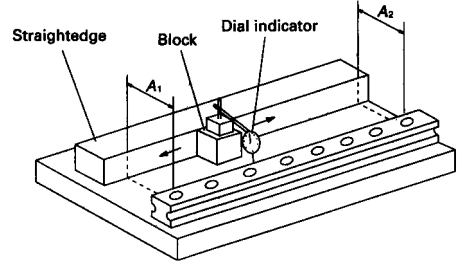

Move the dial indicator along the straightedge, and take readings at every bolt hole along the rail. Make fine adjustment of the rail to the straightedge until the desired reading is made, and tighten the bolt to the specified torque.

When all of the bolts have been tightened, slide the dial indicator from one end of the rail to the other to ensure that the desired straightness has been achieved.

Position the dial indicator on two ball slides on the reference rail as shown in the diagram. Tighten bolts of the adjusting side rail sequentially from the one end while noting the reading of the dial indicator.

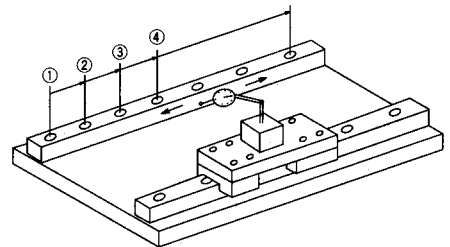

Straightness of NSK linear guides is controlled so that it can be easily adjusted manually for easy installation.

During installation, it is recommended that accuracy is checked to ensure smooth operation.



This section describes the allowable tolerances for installation in order to maximize the performance of NSK linear guides.

We recommend that the mounting errors  $e_1$  or  $e_2$  do not exceed the values shown in the table below. Consult "Precision Machine Components" catalog for linear guides series not shown.

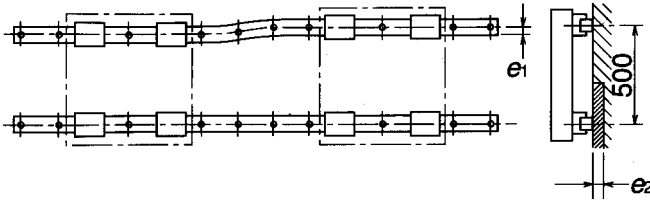

**Recommended allowable installation error of the NS Series (Maximum)**

Item		Model No.	15	20	25	30	35
Clearance Z0, ZT	Permissible values of parallelism in two rails: $e_1$		20	22	30	35	40
	Permissible values of parallelism (height) in two rails: $e_2$		375 $\mu$ m/500mm				
Preload Z1, ZZ	Permissible values of parallelism in two rails: $e_1$		15	17	20	25	30
	Permissible values of parallelism (height) in two rails: $e_2$		330 $\mu$ m/500mm				

**Recommended allowable installation error of the NH Series (Maximum)**

Item		Model No.	20	25	30	35	45	55	65
Clearance Z0, ZT	Permissible values of parallelism in two rails: $e_1$		30	40	45	55	65	80	110
	Permissible values of parallelism (height) in two rails: $e_2$		375 $\mu$ m/500mm						
Preload Z1, ZZ	Permissible values of parallelism in two rails: $e_1$		20	25	30	35	45	55	70
	Permissible values of parallelism (height) in two rails: $e_2$		330 $\mu$ m/500mm						

If the error readings are equal to or less than the above values, you have correctly assembled the parts. For maximum accuracy, keep the readings below what is shown in the table.

If your readings are greater than these values, it is necessary to remove the parts and start over. Please contact your local NSK office with any questions or for assistance. Visit [www.nskamericas.com](http://www.nskamericas.com) for contact information.

# K1™ Handling Instructions

To maintain the NSK K1™ Seal's high efficiency over a long period of time, please follow these instructions.

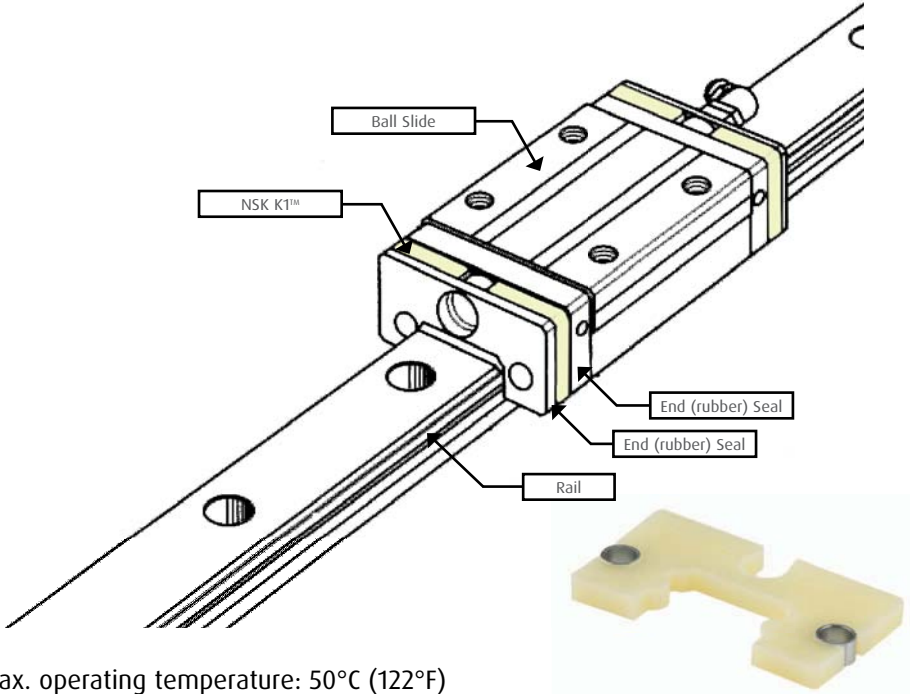

1. Max. operating temperature: 50°C (122°F)  
Max. peak temperature: 80°C (176°F)  
If not installed immediately, they should be kept refrigerated.  
Avoid storage in direct sunlight.
2. Never leave the linear guide in close proximity to grease-removing organic solvents such as hexane, thinners, etc. Never immerse the linear guide in kerosene or rust preventative oils which contain kerosene.

## Note

Other oils such as: water-based cutting oil, oil-based cutting oil, grease (mineral oil-AS2, ester-PS2) present no problems to the K1™ lubricating units performance.

# K1™ Assembly Instructions

1. Slide linear bearing on to the linear rail, using the plastic provisional rail supplied.
2. Remove the grease fitting from the end of the bearing.
3. Remove the Phillips screws (2 pieces).
4. Remove the end seal from end of bearing.
5. Install threaded plug from K1™ kit (or see option 9 and 10 depending on application).
6. Install the cover plate from the K1™ kit, to the end of bearing, against the end cap.
7. Install K1™ lubricating unit without fixing rings, so it can be expanded over the rail.
8. Put the three (3) fixing rings in position on the K1™ lubricating unit.
9. Replace the end seal, in front of the K1™ lubricating unit.
10. Install connector screw for grease fitting.
11. Replace the grease fitting in connector screw.
12. Install the **extension** Phillips screws (2 pieces, supplied with the K1™ seal kit).

## Note

The K1™ lubricating unit has a shelf life. They should be installed immediately upon receipt. It is important to avoid direct sunlight and extreme heat conditions.



## **NSK AMERICAS**

### **Argentina**

NSK Argentina SRL  
Buenos Aires  
54.11.4762.6556

### **Brazil**

NSK Brasil Ltda.  
Sao Paulo SP  
55.11.3269.4700

### **Canada**

NSK Canada Inc.  
Mississauga ON  
1.877.994.6675

### **Latin America**

NSK Latin America Inc.  
Miami FL  
1.305.477.0605

### **Mexico**

NSK Rodamientos Mexicana, S.A. de C.V.  
Tlaineapantla de Baz MX  
52.55.3682.2900

### **United States**

NSK Corporation  
Ann Arbor MI  
1.888.446.5675

**Website:** [www.nskamericas.com](http://www.nskamericas.com)  
**NSK Global:** [www.nsk.com](http://www.nsk.com)

Every care has been taken to ensure the accuracy of the data contained in this brochure, but no liability can be accepted for any loss or damage suffered through errors or omissions.

Printed in the USA ©NSK 2015. The contents of this publication are the copyright of the publishers.